

SKETCH ELEVATION.

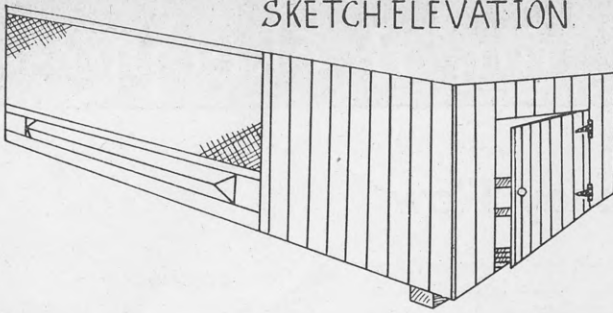

END ELEVATION.

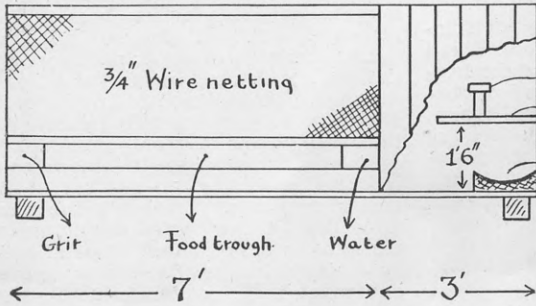
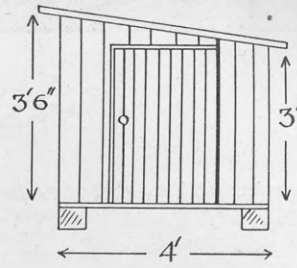

FRONT ELEVATION.

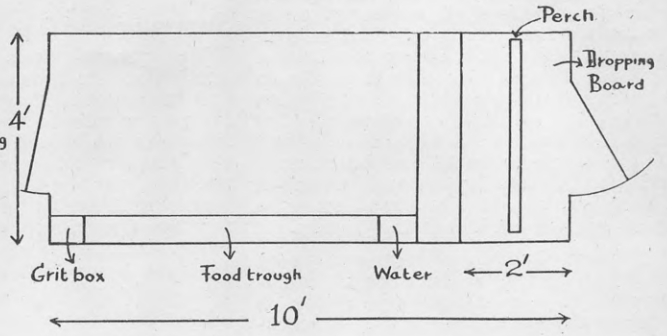

PLAN

Back-yard Poultry House for 6 Birds.

PLAN.

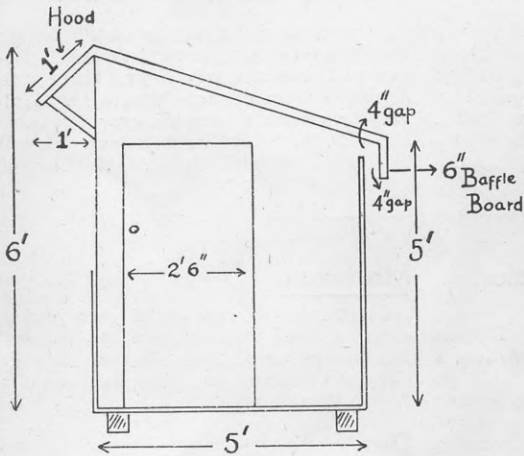

END ELEVATION

Back-yard Poultry House.
For
12 Birds

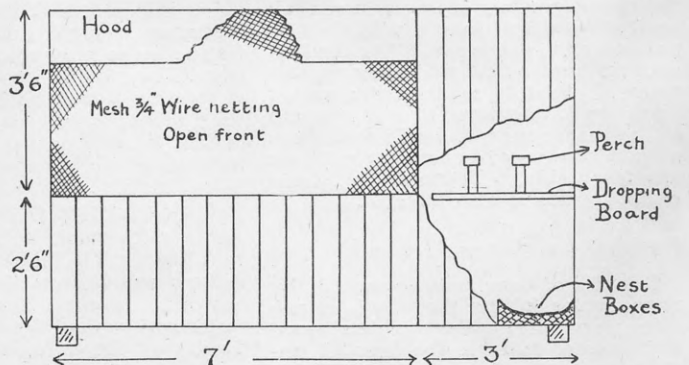
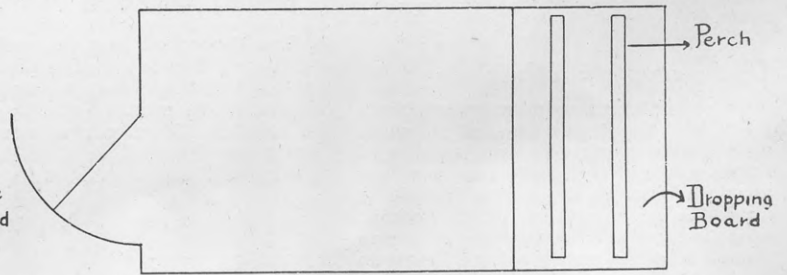

FRONT ELEVATION.